

DATA SHEET

# Electronic overload relay EF19 and EF45

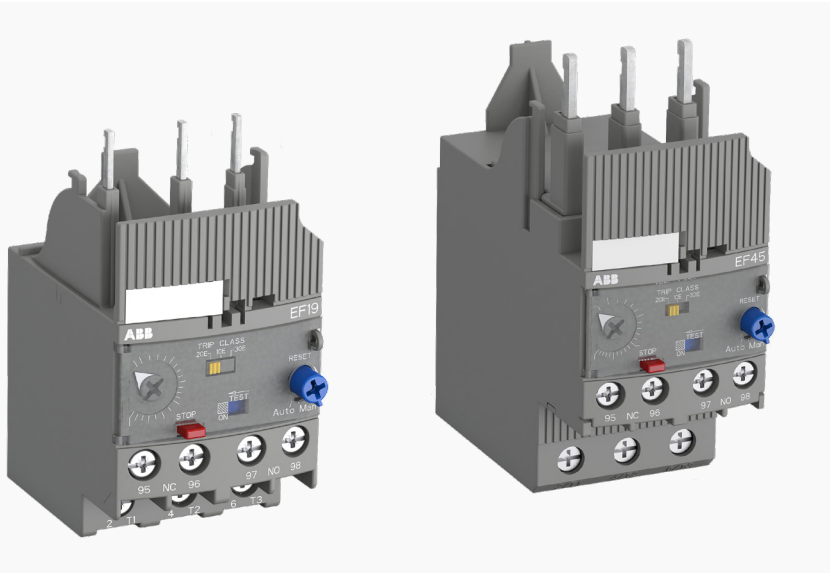

Electronic overload relays offer reliable protection in case of overload and phase-failure. They are the alternative for overload protection to thermal overload relays. Motor starters are combinations of overload

### Description

- Overload protection – trip class 10E, 20E, 30E selectable
- Phase loss sensitivity
- Temperature compensation from -25 ... +70 °C
- Adjustable current setting for overload protection
- Automatic or manual reset selectable
- Trip-free mechanism
- Status indication
- STOP and TEST function
- Direct mounting onto block contactors
- Sealable operating elements
- Self-supplied devices



### Order data

EF19 and EF45 screw terminal  
For AF09 ... AF38 block contactors

Setting range	Type	Order code	Weight Pkg (1 pce) kg
A			
0.10 ... 0.32	EF19-0.32 (1)	1SAX121001R1101	0.158
0.30 ... 1.00	EF19-1.0 (1)	1SAX121001R1102	0.158
0.80 ... 2.70	EF19-2.7 (1)	1SAX121001R1103	0.158
1.90 ... 6.30	EF19-6.3 (1)	1SAX121001R1104	0.158
5.70 ... 18.9	EF19-18.9 (1)	1SAX121001R1105	0.158
9.00 ... 30.0	EF45-30 (2)	1SAX221001R1101	0.362
15.0 ... 45.0	EF45-45 (2)	1SAX221001R1102	0.362

Accessories	Type	Order code	Suitable for	Weight Pkg (1 pce)
Single mounting kit	DB19EF	1SAX101910R1001	EF19	0.046
	DB45EF	1SAX201910R0001	EF45	0.100

(1) Suitable for mounting on AF09 ... AF38  
(2) Suitable for mounting on AF26 ... AF38

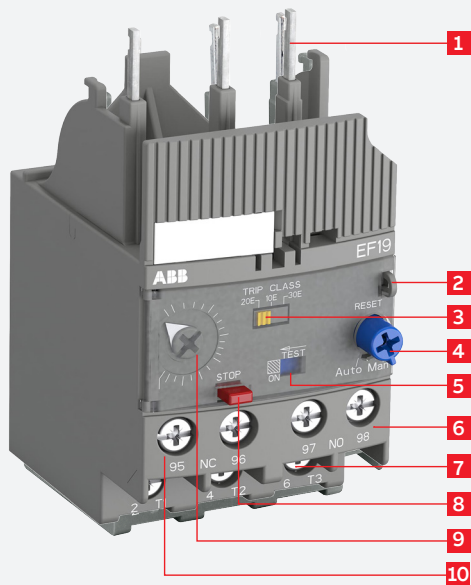

**Functional description**

1. Terminals (1L1, 3L2, 5L3)
2. Sealable operating elements
3. Trip class 10E, 20E, 30E selectable
4. RESET  
Automatic or manual reset selectable
5. TEST - Status indication
6. Signaling contacts 97-98
7. Terminals 2T1, 4T2, 6T3
8. STOP
9. Current setting range / Self-test function ST  
Adjustable current setting for overload protection
10. Tripping contacts 95-96

**Application / internal function**

The self-supplied electronic overload relays are three pole electronic/mechanical devices. The motor current flows through build-in current transformers and an evaluation circuit will recognize an overload (over current). This will lead to a release of the relay and a change of the contacts switching position (95-96 / 97-98). The contact 95-96 is used to control the load contactor. The electronic overload relay is self-supplied, which mean no extra external supply is needed.

The overload relays have a setting scale in Amperes, which allows the direct adjusting of the relay without any additional calculation. In compliance with international and national standards, the setting current is the rated current of the motor and not the tripping current (no tripping at  $1.05 \times I$ , tripping at  $1.2 \times I$ ;  $I$  = setting current). The relays are constructed in a way that they protect themselves in the event of an overload. The overload relay has to be protected against short-circuit. The appropriate short-circuit protective devices are shown in the following tables. To prevent thermal overloads in heavy duty applications, the correct cable sizes have to be selected.

**Operation mode**

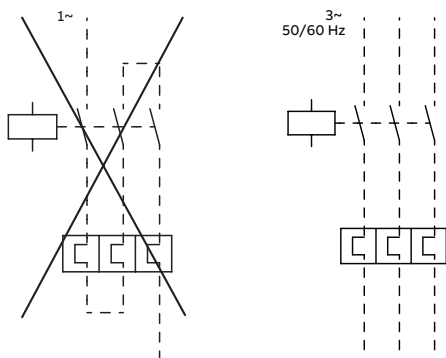

	Contact 95-96	Contact 97-98	Opto-mechanical slide	Comment
Trip state	open	closed		
RESET state	closed	open	ON	
TEST manual reset mode	open	closed		
TEST auto reset mode	open	closed		
STOP while device is in trip state	open	closed		STOP button has no function
STOP while device is in RESET state	open	open		while STOP button is pressed

**Wiring diagram**

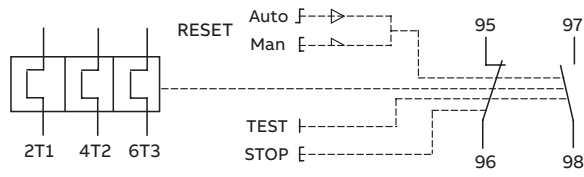

**Resistance and power loss per pole and short-circuit protective devices**

Type	Setting range		Resistance per pole mΩ	Power loss per pole at lower value    at upper value		Short-circuit protective devices coordination type 2
	lower value A	upper value A		W	W	
EF19-0.32	0.1	0.32	447	0.004	0.046	Fuse 1 A, Type gG
EF19-1.0	0.3	1	54	0.005	0.054	Fuse 4 A, Type gG
EF19-2.7	0.8	2.7	7.9	0.005	0.058	Fuse 10 A, Type gG
EF19-6.3	1.9	6.3	2.1	0.008	0.083	Fuse 20 A, Type gG
EF19-18.9	5.7	18.9	0.85	0.028	0.304	Fuse 50 A, Type gG
EF45-30	9	30	0.26	0.021	0.234	Fuse 160 A, Type gG
EF45-45	15	45	0.26	0.059	0.527	Fuse 160 A, Type gG

**Intermittent periodic duty**

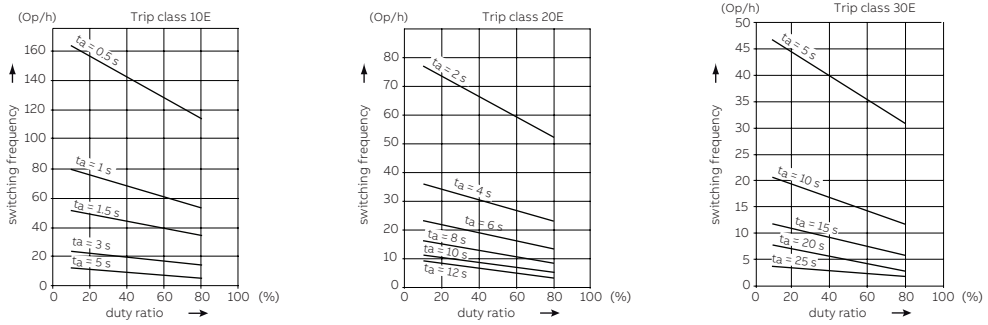

**Dimensions**

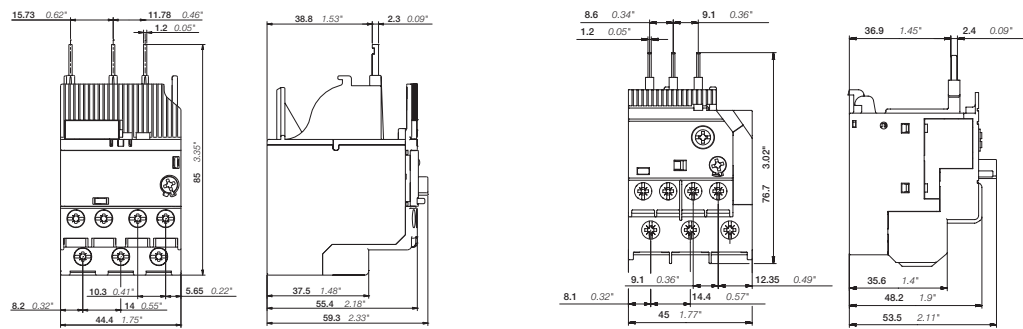

EF19

EF45

**Technical data IEC/EN**

Data at Ta = 40 °C and at rated values, if nothing else indicated





**Main circuit**

<b>EF19, EF45</b>	
Rated operational voltage Ue	690 V AC
	- V DC
Setting range - electronic overload protection	see table on page 1
Rated operational current AC-3 Ie	see upper value of setting range, on page 3
Trip class	10E, 20E, 30E, selectable
Rated frequency	50/60 Hz
Number of poles	3
Resistance per pole	see table on page 3
Power loss per pole	see table on page 3
Short-circuit protective devices	see table on page 3

**Isolation data**

<b>EF19, EF45</b>	
Rated impulse withstand voltage Uimp	6 kV
Rated insulation voltage Ui	690 V
Pollution degree	3
Overvoltage category	up to III

**Electrical connection**

Type	<b>EF19</b>	<b>EF45</b>	<b>DB19EF</b>	<b>DB45EF</b>
 rigid	1 x 1 ... 4 mm <sup>2</sup> 2 x 1 ... 4 mm <sup>2</sup>	1 x 2.5 ... 16 mm <sup>2</sup> 2 x 2.5 ... 16 mm <sup>2</sup>	1 x 1 ... 4 mm <sup>2</sup>	1 x 2.5 ... 16 mm <sup>2</sup> 2 x 2.5 ... 16 mm <sup>2</sup>
 flexible with ferrule	1 x 0.75 ... 2.5 mm <sup>2</sup> 2 x 0.75 ... 2.5 mm <sup>2</sup>	1 x 2.5 ... 16 mm <sup>2</sup> 2 x 2.5 ... 16 mm <sup>2</sup>	1 x 0.75 ... 2.5 mm <sup>2</sup>	1 x 2.5 ... 16 mm <sup>2</sup> 2 x 2.5 ... 16 mm <sup>2</sup>
 flexible with ferrule insulated	1 x 0.75 ... 2.5 mm <sup>2</sup> 2 x 0.75 ... 2.5 mm <sup>2</sup>	1 x 2.5 ... 16 mm <sup>2</sup> 2 x 2.5 ... 16 mm <sup>2</sup>	1 x 0.75 ... 2.5 mm <sup>2</sup>	1 x 2.5 ... 16 mm <sup>2</sup> 2 x 2.5 ... 16 mm <sup>2</sup>
 flexible	1 x 0.75 ... 2.5 mm <sup>2</sup> 2 x 0.75 ... 2.5 mm <sup>2</sup>	1 x 2.5 ... 16 mm <sup>2</sup> 2 x 2.5 ... 16 mm <sup>2</sup>	1 x 0.75 ... 2.5 mm <sup>2</sup>	1 x 2.5 ... 16 mm <sup>2</sup> 2 x 2.5 ... 16 mm <sup>2</sup>
Stripping length	9 mm	13 mm	12 mm	15 mm
Tightening torque	0.8 ... 1.5 Nm	2.3 ... 2.6 Nm	0.8 ... 1.5 Nm	0.8 ... 1.5 Nm
Recommended screw driver	Pozidriv 2	Pozidriv 2	Pozidriv 2	Pozidriv 2





**Auxiliary circuit**

		<b>95-96, 97-98</b>
Rated operational voltage Ue		600 V AC / DC
Conventional free air thermal current Ith		6 A
Rated frequency		DC, 50/60 Hz
Number of poles		1 N.C. + 1 N.O.
Rated operational current Ie acc. to IEC/EN 60947-5-1 for utilization category		
at AC-15 at 110-120 V	N.C. 95-96	3.00 A
	N.O. 97-98	3.00 A
at AC-15 at 220-230-240 V	N.C. 95-96	3.00 A
	N.O. 97-98	3.00 A
at AC-15 at 400 V	N.C. 95-96	1.10 A
	N.O. 97-98	1.10 A
at AC-15 at 480-500 V	N.C. 95-96	0.75 A
	N.O. 97-98	0.75 A
at DC-13 at 24 V	N.C. 95-96	1.50 A
	N.O. 97-98	1.50 A
at DC-13 at 110-120-125 V	N.C. 95-96	0.55 A
	N.O. 97-98	0.55 A
at DC-13 at 250 V	N.C. 95-96	0.27 A
	N.O. 97-98	0.27 A
at DC-13 at 500 V	N.C. 95-96	0.10 A
	N.O. 97-98	0.10 A
Minimum switching capacity		12 V / 3 mA $\lambda = 10^{-7}$ ; Ukd = 3 V / 500.000 operating cycles
Short-circuit protective devices		fuse 6 A, Type gG

**Isolation data**

		<b>95-96, 97-98</b>
Rated impulse withstand voltage Uimp		6 kV
Rated insulation voltage Ui		690 V
Pollution degree		3
Overvoltage category		up to III

**Electrical connection**

Type	<b>95-96, 97-98</b>	
 rigid	1 x 1 ... 4 mm <sup>2</sup> 2 x 1 ... 4 mm <sup>2</sup>	
 flexible with ferrule	1 x 0.75 ... 2.5 mm <sup>2</sup> 2 x 0.75 ... 2.5 mm <sup>2</sup>	
 flexible with ferrule insulated	1 x 0.75 ... 2.5 mm <sup>2</sup> 2 x 0.75 ... 2.5 mm <sup>2</sup>	
 flexible	1 x 0.75 ... 2.5 mm <sup>2</sup> 2 x 0.75 ... 2.5 mm <sup>2</sup>	
Stripping length		9 mm
Tightening torque		0.8 ... 1.2 Nm
Recommended screw driver		Pozidriv 2

**General data**

Duty time		100 %
Operating frequency without early tripping		up to 15 operations/h or 60 operations/h with 40 % duty ratio, if the motor breaking current $6 \times I_n$ and the motor starting time does not exceed 1 s
Dimensions (W x H x D)		see dimension drawing
Weight		see ordering data
Mounting		mount on the contactor and tighten the screws of the main circuit terminals or with single mounting kit on DIN rail (35 mm)
Mounting position		optional, position 1-6
Minimum distance to other units same type	horizontal	none
	vertical	not applicable
Minimum distance to electrical conductive board	horizontal	1.5 mm
	vertical	1.5 mm
Degree of protection	housing	IP20
	main circuit terminals	IP20
Maximum operating altitude		2000 m

**Electromagnetic compatibility**

Immunity acc. to IEC 60947-1		Environment A
Emission acc. to IEC 60947-1		Environment B

**Environmental data**

Ambient air temperature		
Operation	open - compensated	-25 ... +70 °C
	open	-25 ... +70 °C
Storage		-50 ... +85 °C
Ambient air temperature compensation		acc. to IEC/EN 60947-4-1
Resistance to vibrations acc. to IEC 60068-2-6		3g / 3 ... 150 Hz
Resistance to shock acc. to IEC 60068-2-27		25g / 11 ms

**Standards / directives**

Standards		IEC/EN 60947-1 IEC/EN 60947-4-1 IEC/EN 60947-5-1 UL 60947-1 UL 60947-4-1
Low Voltage Directive		2014/35/EU
EMC Directive		2014/30/EU
RoHS Directive		2011/65/EU

## Technical data UL/CSA

### Full load amps and short-circuit protective devices

Type	Full load amps (FLA)	Short circuit protective devices									
		480 V AC		480 V AC		600 V AC		600 V AC		600 V AC	
		SCCR	Fuse K5 / RK5	SCCR	Circuit breaker	SCCR	Fuse K5 / RK5	SCCR	Fuse J	SCCR	Circuit breaker
EF19-0.32	0.32 A	50 kA	2 A (1)	65 kA	15 A	5 kA	2 A	100 kA	2 A	-	-
EF19-1.0	1 A	50 kA	2 A	65 kA	15 A	5 kA	2 A	100 kA	2 A	-	-
EF19-2.7	2.7 A	50 kA	4 A	65 kA	15 A	5 kA	4 A	100 kA	4 A	-	-
EF19-6.3	6.3 A	50 kA	15 A	65 kA	35 A	5 kA	15 A	100 kA	15 A	-	-
EF19-18.9	18.9	50 kA	30 A	65 kA	35 A	5 kA	30 A	100 kA	30 A	10 kA	20 A
EF45-30	30	18 kA (2)	150 A (2)	65 kA	70 A	5 kA	150 A	100 kA	150 A	-	-
EF45-45	45 A	18 kA (2)	250 A (2)	65 kA	70 A	5 kA	250 A	100 kA	250 A	-	-



(1) Class J fuse

(2) At 600 V AC

### Main circuit

Maximum operational voltage	600 V AC
Trip rating	125 % of FLA
Full load amps (FLA)	see table above
Short-circuit rating RMS symmetrical	see table above
Short-circuit protective devices	see table above



### Electrical connection

Type	EF19	EF45	DB19EF	DB45EF
 stranded	1 x AWG 16 ... 10 2 x AWG 16 ... 10	1 x AWG 14 ... 6 2 x AWG 14 ... 6	1 x AWG 16 ... 10 2 x AWG 16 ... 10	1 x AWG 18 ... 10 2 x AWG 18 ... 10
 flexible with ferrule	1 x AWG 16 ... 10 2 x AWG 16 ... 10	1 x AWG 14 ... 6 2 x AWG 14 ... 6	1 x AWG 16 ... 10 2 x AWG 16 ... 10	1 x AWG 18 ... 10 2 x AWG 18 ... 10
Stripping length	9 mm	13 mm	12 mm	15 mm
Tightening torque	7 ... 13 lb.in	20 ... 22 lb.in	7 ... 13 lb.in	7 ... 13 lb.in
Recommended screw driver	Pozidriv 2 / M3.5	Pozidriv 2 / M5	Pozidriv 2 / M3	Pozidriv 2 / M3

### Auxiliary circuit

Conventional thermal current	5 A
Making and breaking capacity	N.C. / N.O. B600, Q600

### Electrical connection

Type	95-96, 97-98
 stranded	1 x AWG 18 ... 10 2 x AWG 18 ... 10
 flexible with ferrules	1 x AWG 18 ... 10 2 x AWG 18 ... 10
Stripping length	9 mm
Tightening torque	7 ... 11 lb.in
Recommended screw driver	Pozidriv 2



---

**ABB STOTZ-KONTAKT GmbH**  
Eppelheimer Straße 82  
D-69123 Heidelberg / Germany  
Phone: +49 (0) 6221 7 01-0  
Fax: +49 (0) 6221 7 01-13 25  
E-Mail: [info.desto@de.abb.com](mailto:info.desto@de.abb.com)

[abb.com/contacts](http://abb.com/contacts)

We reserve the right to make technical changes or modify the contents of this document without prior notice. With regards to purchase orders, the agreed particulars shall prevail. ABB AG does not accept any responsibility whatsoever for potential errors or possible lack of information in this document.

We reserve all rights in this document and in the subject matter and illustrations contained therein. Any reproduction, disclosure to third parties or utilization of its contents – in whole or in parts – is forbidden without prior written consent of ABB AG.

Copyright© 2021 ABB - All rights reserved